

NOTES:

1. MATERIAL: KBr
2. CLEAR APERTURE: 85%
3. PARALLELISM: (S1&S2) 3 ARC MIN
4. FLATNESS: (S1&S2) 1/10 WAVE @ 10.6 μm
5. SURFACE FINISH: (S1&S2) 60/40
6. UNCOATED

REVISION HISTORY				
REV	DCO	DESCRIPTION	DATE	INITIALS
A	6033	INITIAL RELEASE	12/10/19	YK

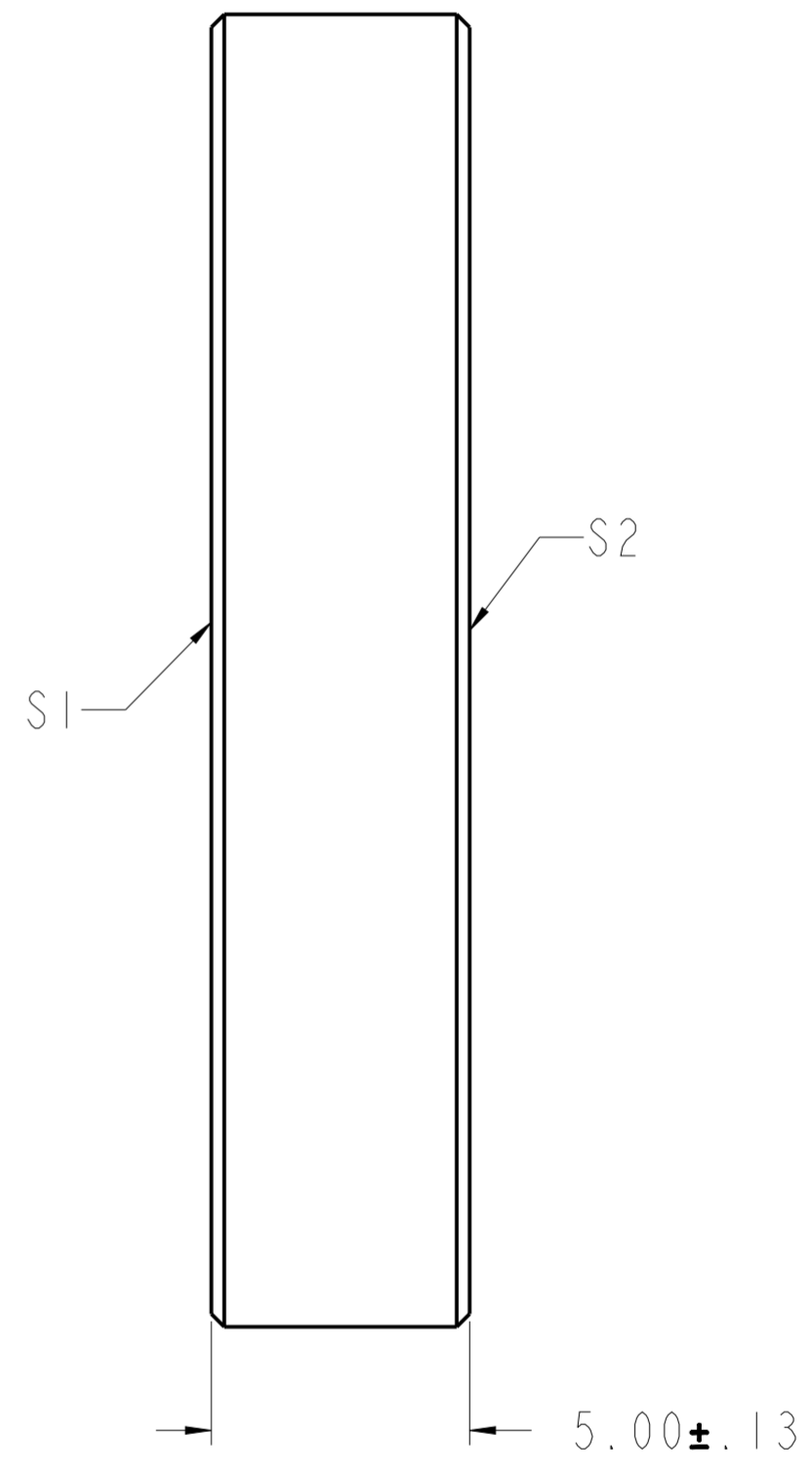
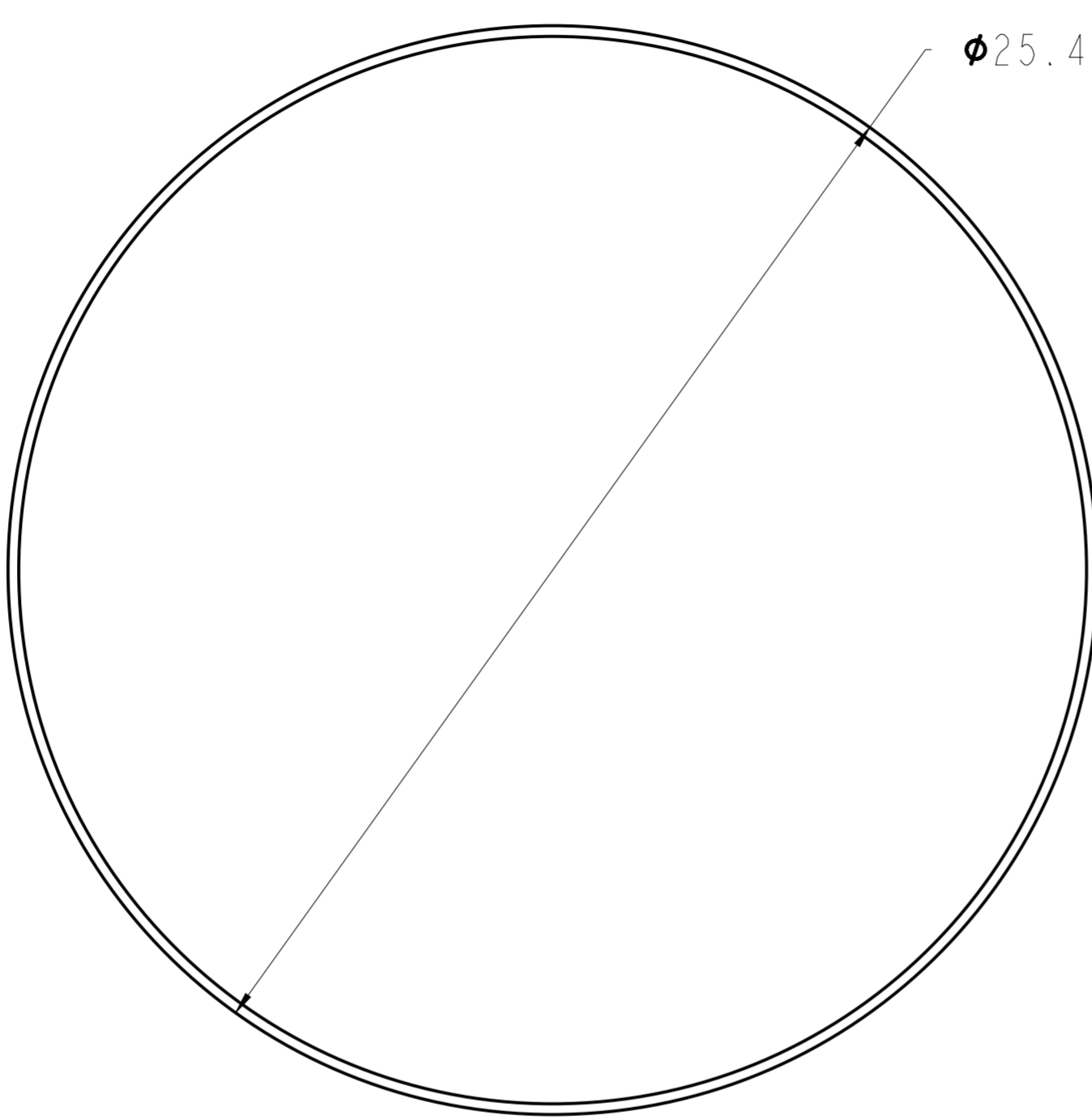

REFERENCE ONLY
NOT FOR MANUFACTURING

UNLESS OTHERWISE SPECIFIED DIMENSIONS ARE IN MM. DECIMAL TOLERANCES ARE: .X ± 0.25 .XX ± 0.10 .XXX ± 0.025 .XXXX ± 0.013 ANGLES: ± 0.5°				<small>PROPRIETARY INFORMATION THIS DOCUMENT CONTAINS PROPRIETARY INFORMATION OF LIGHTPATH TECHNOLOGIES AND IS NOT TO BE DISCLOSED OR REPRODUCED IN WHOLE OR PART, OR USED FOR MANUFACTURING FOR ANYONE OTHER THAN LIGHTPATH TECHNOLOGIES WITHOUT ITS WRITTEN CONSENT. NO RIGHT IS GRANTED TO DISCLOSE OR USE ANY INFORMATION CONTAINED IN SAID DOCUMENT.</small>	
DRAWN BH		TITLE WINDOW - KBr - 25.4 X 5.0			
MATERIAL KBr		SIZE A2	DWG NO KB-W-25-5 - CAT	REV A	
SOFTWARE Pro/ENGINEER		SCALE: 7.00	THIRD ANGLE PROJECTION	SHEET 1 OF 1	

DWG NO
KB-W-25-5