

NOTES:

1. MATERIAL: BaF2
2. CLEAR APERTURE: 85%
3. PARALLELISM: (S1&S2) 3 ARC MIN
4. FLATNESS: (S1&S2) 2 WAVES PER INCH @ 633 nm
5. SURFACE FINISH: (S1&S2) 40/20
6. UNCOATED

REVISION HISTORY				
REV	DCO	DESCRIPTION	DATE	INITIALS
A	6020	INITIAL RELEASE	11/27/19	YK

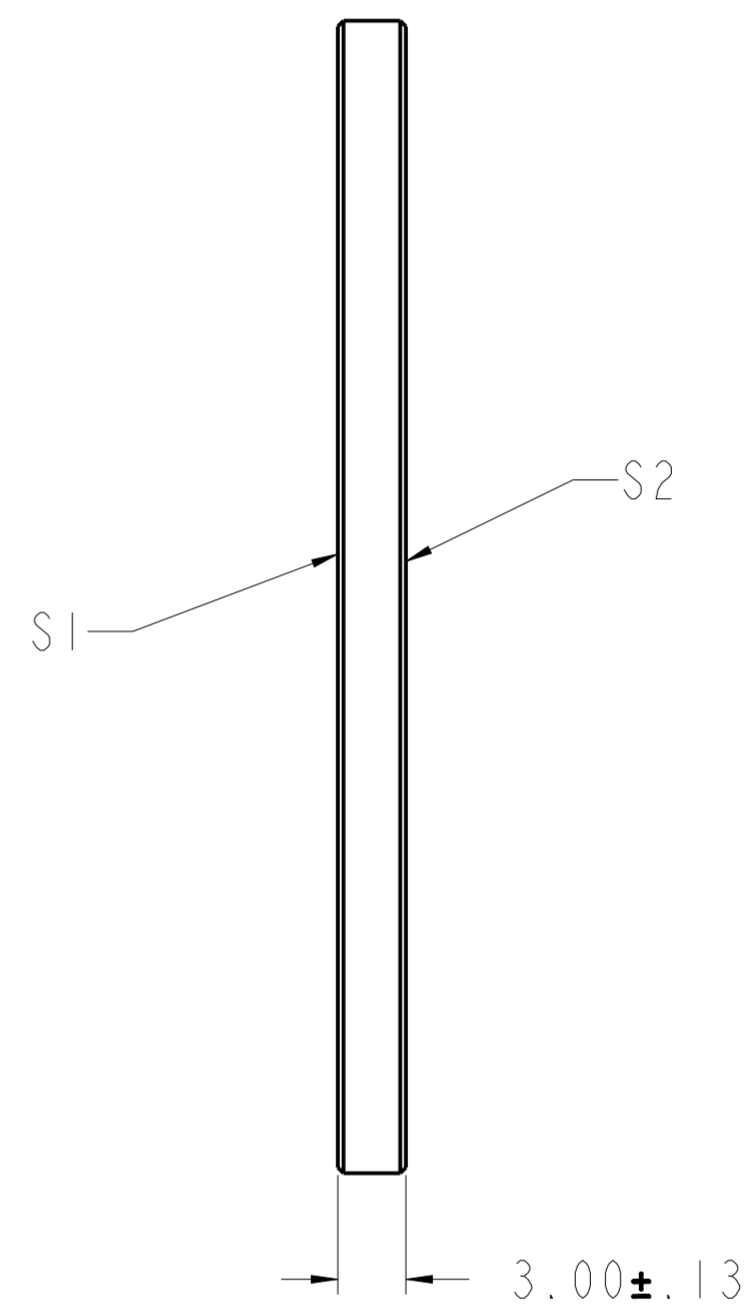
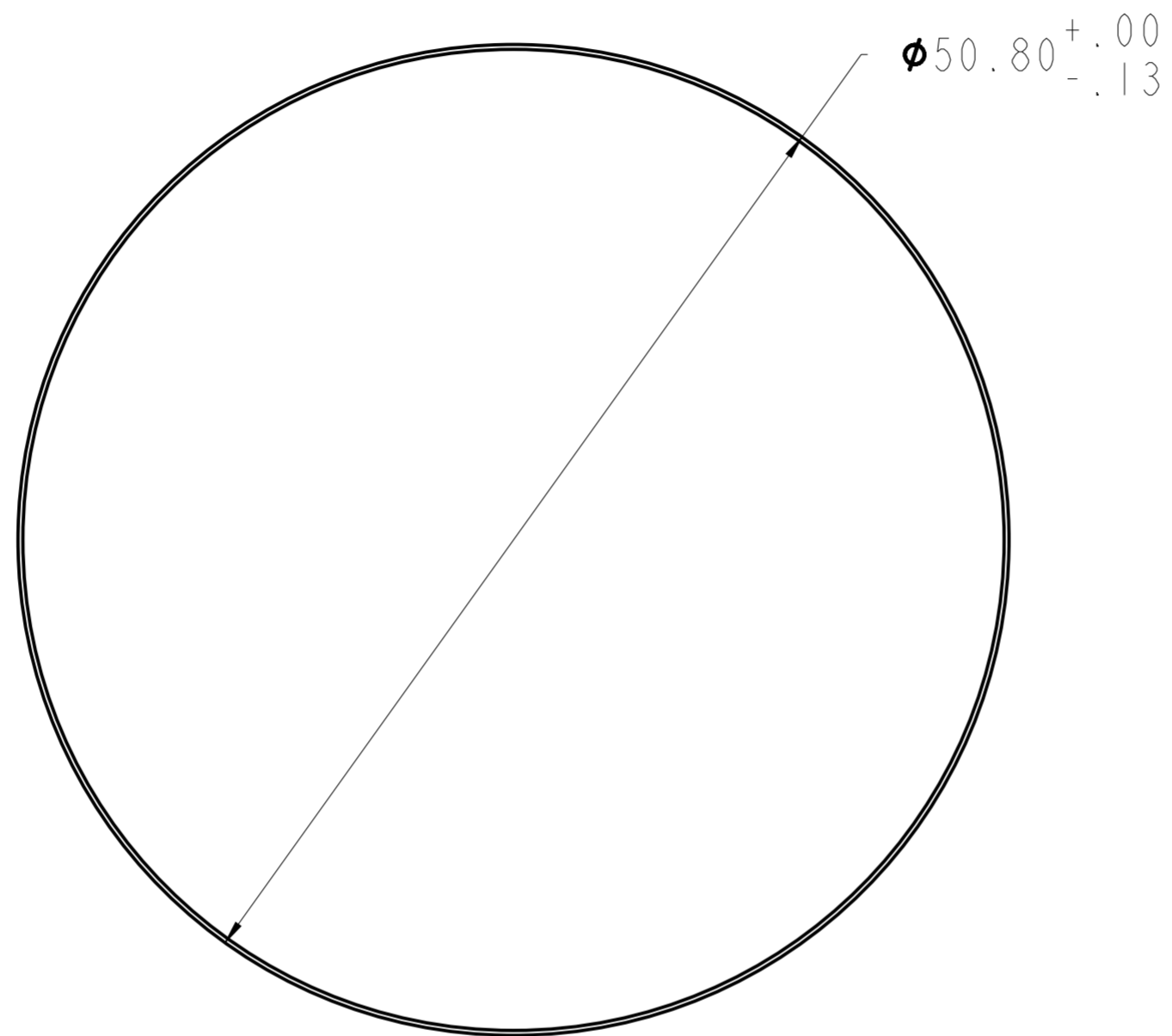

REFERENCE ONLY
NOT FOR MANUFACTURING

UNLESS OTHERWISE SPECIFIED DIMENSIONS ARE IN MM. DECIMAL TOLERANCES ARE: .X ± 0.25 .XX ± 0.10 .XXX ± 0.025 .XXXX ± 0.013 ANGLES: ± 0.5°				<small>PROPRIETARY INFORMATION THIS DOCUMENT CONTAINS PROPRIETARY INFORMATION OF LIGHTPATH TECHNOLOGIES AND IS NOT TO BE DISCLOSED OR REPRODUCED IN WHOLE OR PART, OR USED FOR MANUFACTURING FOR ANYONE OTHER THAN LIGHTPATH TECHNOLOGIES WITHOUT ITS WRITTEN CONSENT. NO RIGHT IS GRANTED TO DISCLOSE OR USE ANY INFORMATION CONTAINED IN SAID DOCUMENT.</small>	
DRAWN BH		TITLE WINDOW - BaF2 - 50.8 X 3.0			
MATERIAL BaF2		SIZE A2	DWG NO BF-W-50-3 - CAT		REV A
SOFTWARE Pro/ENGINEER		SCALE: 3.00	THIRD ANGLE PROJECTION 		SHEET 1 OF 1

DWG NO
BF-W-50-3