

REVISION HISTORY				
REV	DCO	DESCRIPTION	DATE	INITIALS
A	5746	INITIAL RELEASE	3/27/19	BH

NOTES:

1. MATERIAL: CVD ZnSe
2. CLEAR APERTURE: 85%
3. PARALLELISM: (S1&S2) 3 ARC MIN
4. FLATNESS: (S1&S2) 1/20 WAVE @ 10.6 μm
5. SURFACE FINISH: (S1&S2) 60/40
6. UNCOATED

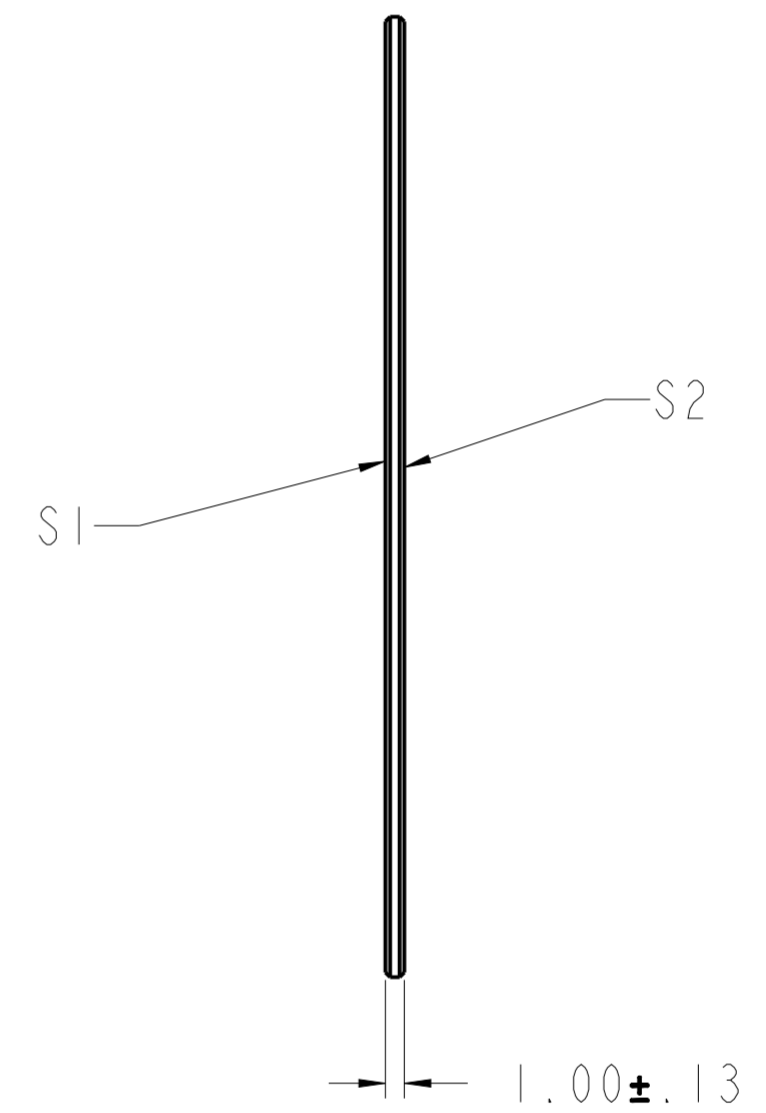
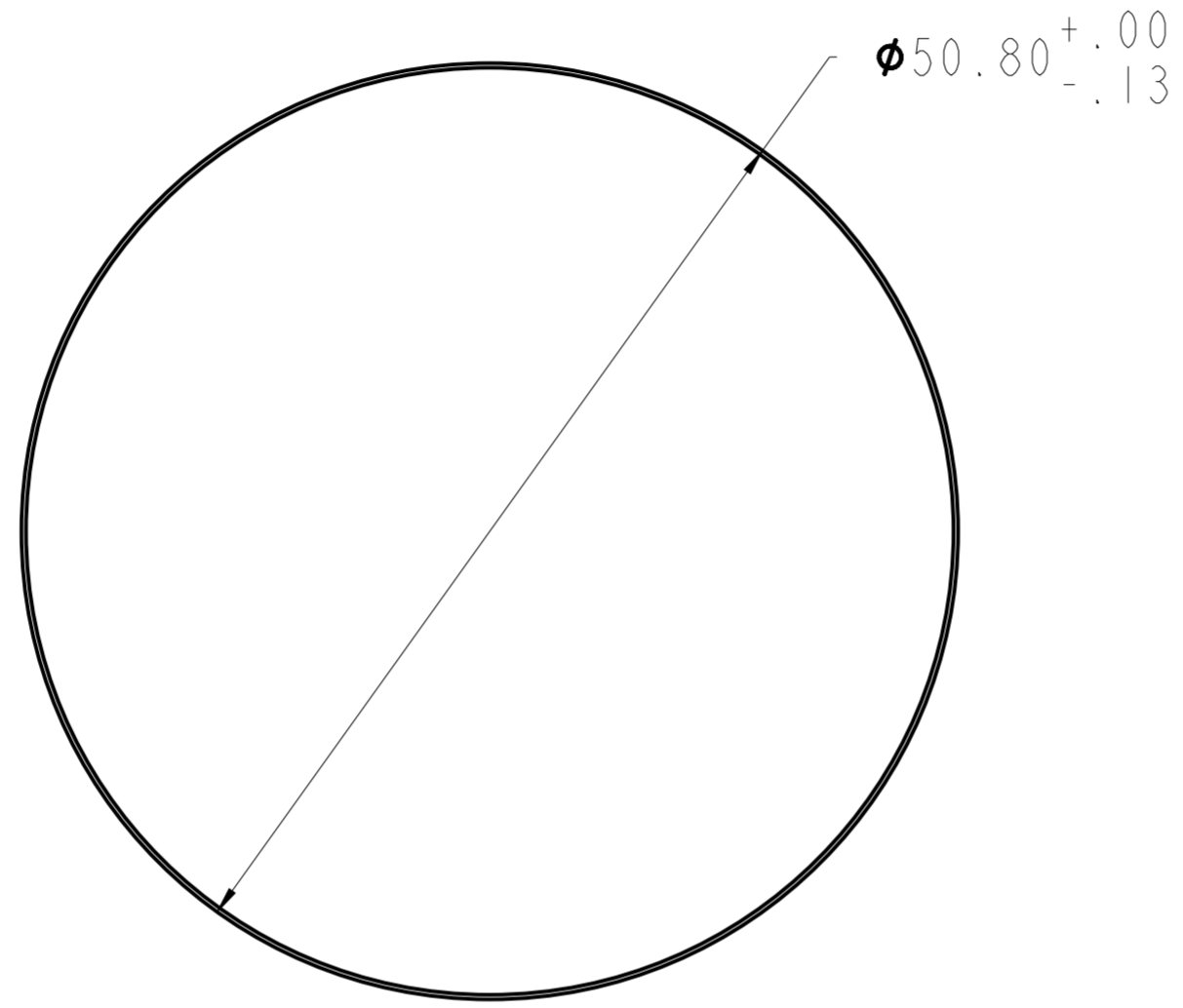

REFERENCE ONLY
NOT FOR MANUFACTURING

UNLESS OTHERWISE SPECIFIED DIMENSIONS ARE IN MM. DECIMAL TOLERANCES ARE: .X ± 0.25 .XX ± 0.10 .XXX ± 0.025 .XXXX ± 0.013 ANGLES: ± 0.5°				<small>THIS DOCUMENT CONTAINS PROPRIETARY INFORMATION OF LIGHTPATH TECHNOLOGIES AND IS NOT TO BE DISCLOSED OR REPRODUCED IN WHOLE OR PART, OR USED FOR MANUFACTURING FOR ANYONE OTHER THAN LIGHTPATH TECHNOLOGIES WITHOUT ITS WRITTEN CONSENT. NO RIGHT IS GRANTED TO DISCLOSE OR USE ANY INFORMATION CONTAINED IN SAID DOCUMENT.</small>	
DRAWN BH		TITLE WINDOW - ZnSe - 50.8 X 1.0			
MATERIAL ZnSe	SIZE A2	DWG NO ZC-W-50-1 - CAT	REV A		
SOFTWARE Pro/ENGINEER	SCALE: 2.50	THIRD ANGLE PROJECTION 	SHEET 1 OF 1		

REV A
 SH I
 DWG NO
 ZC-W-50-1